

VSXT-VMXT-VTXX

PN16 Fan Coil Unit Valves

MODEL	DESCRIPTION
VSXT..	Two-way valve DN 1/2" - 1"; Kvs 0,25 - 6 m ³ /h
VMXT..	Three-way valve DN 1/2" - 1"; Kvs 0,25 - 6 m ³ /h (4 angle way)
VTXT..	Three-way valve with built in by-pass DN 1/2" - 3/4"; Kvs 0,25 - 6 m ³ /h (4 angle way)



APPLICATION AND USE

V.XT series valves are used for hot and chilled water control in two- or four-pipe fan coil units, zone plants, solar plants, small re-heaters and dehumidifiers, in electric/electronic temperature control systems. They are motorized by MVT.03S and MVC503R actuators.

MANUFACTURING CHARACTERISTICS

CHARACTERISTIC	DESCRIPTION
Valve body	Brass
Seat	Reinforced technopolymer
Plug	Fortron plug with EPDM double OR
Stem	Stainless steel
Stem packing	EPDM double OR

All models are normally closed, i.e. the action of the valve spring makes the plug move to the upper seat, even with disassembled actuator.

TECHNICAL CHARACTERISTICS

CHARACTERISTIC	DESCRIPTION
Operating pressure	1600 kPa max (16 bar)
Control characteristics	Equal percentage A-AB port, linear B-AB for Kv 0.25 to 2.5 linear A-AB port, linear B-AB for Kv4 and Kv6
Control stroke	5,5 mm
Max fluid speed	3 m/s
Allowed fluids	Water: 5T95°C; glycol-added: max 30%
Connections	Male threaded gas connection flat or conic tight

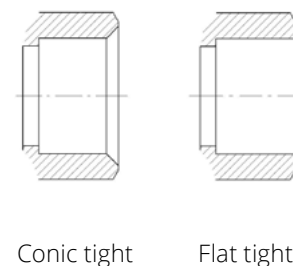

Conic tight

Flat tight

The performances stated in this sheet can be modified without any prior notice.

OPERATION

V.XT valves without the actuator are normally closed (with reference to the direct way). The plug with double EPDM O-ring ensures tight close-off on both straight and angle way in all V.XT models. The valve tight close-off with DeltaP max is guaranteed by the valve spring, even without actuator.

INSTALLATION AND MOUNTING

Before installing the valve, make sure that pipes are clean, free from foreign matter, perfectly aligned with the valve body and not subjected to vibration.

The valve can be mounted in any position but with the stem pointing downwards. 3-way valves must be used as mixing valves. Should valves be installed as diverting (one inlet two outlets) a reduction to 1/3 of the declared value will result in the max. differential pressure for standard operation.

Allowed mounting position

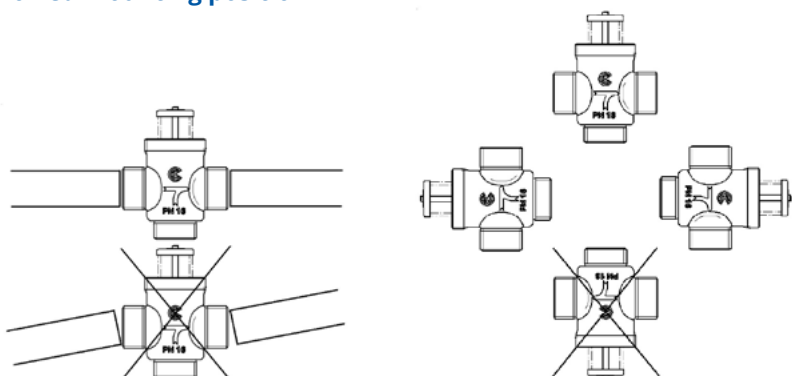

COUPLING VALVES V.XT

With MVT and MVC actuator

Before coupling the actuator to the valve, check that the thrust screw is at the top. If this is not the case, bear in mind that, in order to correctly position the actuator on the valve, the spring force of the valve must be overcome; then tighten the ring nut M30x1.5 on the thread on the valve body.

Type	Model	Connections	Flow rate [m ³ /h]	Dp max [kPa]
2-way	VSXT09P	G 1/2" flat tight	0,25	400
	VSXT10P		0,4	
	VSXT11P		0,6	350
	VSXT12P		1	
	VSXT13P		1,6	
	VSXT1P		2	
	VSXT21P	G 3/4" flat tight	2,5	150
	VSXT24P		4	
	VSXT26P	6		
	VSXT28P	G 1" flat tight	6	
	VSXT09	G 1/2" conic tight	0,25	400
	VSXT10		0,4	
	VSXT11		0,6	350
	VSXT12		1	
VSXT13	1,6			
VSXT1	2			
VSXT21	G 3/4" conic tight		2,5	

Type	Model	Connections	Flow rate [m³/h]	Dp max [kPa]	
3-way	VMXT09P	G 1/2" flat tight	0,25 (0,25)	400	
	VMXT10P		0,4 (0,4)		
	VMXT11P		0,6 (0,6)	350	
	VMXT12P		1 (0,6)		
	VMXT13P		1,6 (1)		
	VMXT1P		2 (1,6)		
	VMXT21P	G 3/4" flat tight	2,5 (2)	100 (40 angle way)	
	VMXT24P		4 (2,5)		
	VMXT26P		6 (4)		
	VMXT28P	G 1" flat tight	6 (4)		
	3-way valves with built-in by-pass (4-ports)	VMXT09	G 1/2" conic tight	0,25 (0,25)	400
		VMXT10		0,4 (0,4)	
		VMXT11		0,6 (0,6)	350
		VMXT12		1 (0,6)	
		VMXT13		1,6 (1)	
		VMXT1		2 (1,6)	
VMXT21		G 3/4" conic tight	2,5 (2)		
3-way valves with built-in by-pass (4-ports)		VTXT09P	G 1/2" flat tight	0,25 (0,25)	400
	VTXT10P	0,4 (0,4)			
	VTXT11P	0,6 (0,6)		350	
	VTXT12P	1 (0,6)			
	VTXT13P	1,6 (1)			
	VTXT1P	2 (1,6)			
	VTXT21P	G 3/4" flat tight	2,5 (2)	100 (40 angle way)	
	VTXT24P		4 (2,5)		
	VTXT26P		6 (4)		
	VTXT09	G 1/2" conic tight	0,25 (0,25)	400	
	VTXT10		0,4 (0,4)		
	VTXT11		0,6 (0,6)	350	
	VTXT12		1 (0,6)		
	VTXT13		1,6 (1)		
	VTXT1		2 (1,6)		
	VTXT21	G 3/4" conic tight	2,5 (2)		
3-way valves with built-in by-pass (4-ports)	VTXT09P4	G 1/2" flat tight interaxis 40 mm	0,25 (0,25)	400	
	VTXT10P4		0,4 (0,4)		
	VTXT11P4		0,6 (0,6)	350	
	VTXT12P4		1 (0,6)		
	VTXT13P4		1,6 (1)		
	VTXT1P4		2 (1,6)		
	VTXT21P4	G 3/4" flat tight interaxis 40 mm	2,5 (2)		

DPmax = max. diff. press. guaranteed with closed valve and open flow
 (*) The values in brackets represent Kvs on angle way

FITTINGS				
CODE	DN	a	b	Quantity
89811-02	15 (1/2")	G 1/2" F	G 3/8" M	2
89811-03	20 (3/4")	G 3/4" F	G 1/2" M	
89811-01	25 (1")	G 1" F	G 3/4" M	

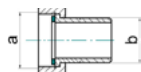

PRESSURE DROP DIAGRAM

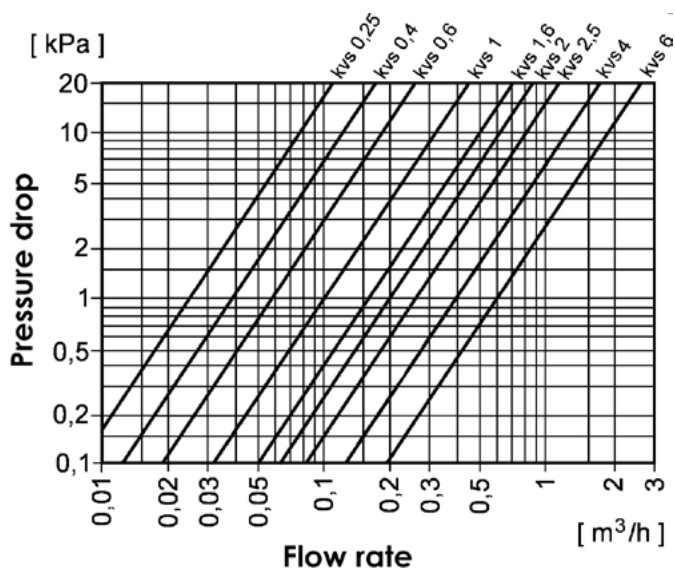

APPLICATION DIAGRAM

2-way valves

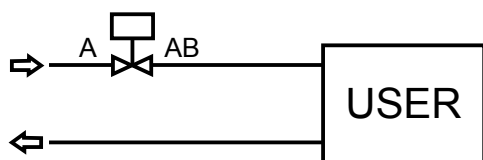

3-way valves

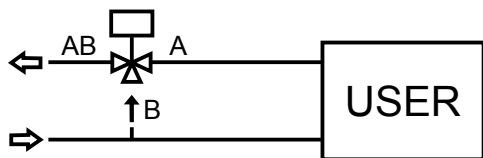

3-way valves with bypass

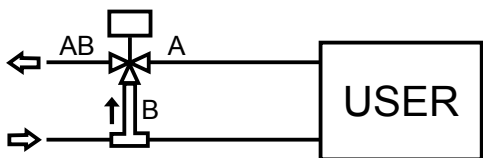

2-way

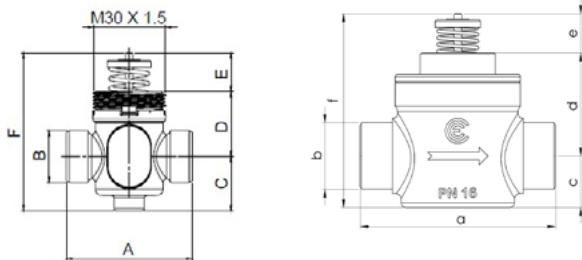

valve	A	B	C	D	E	F	attuatore
VSXT09P VSXT10P VSXT11P VSXT12P VSXT13P VSXT13	52	G1/2" M	22,5	27	15,6	65	MVT203S MVT403S MVT503S MVC503R
VSXT21 VSXT21P	56	G3/4" M	23,6	25,8			
VSXT24P VSXT26P	78	G3/4" M	20,5	41	77,1		
VSXT28P	78	G1" M		41			

3-way

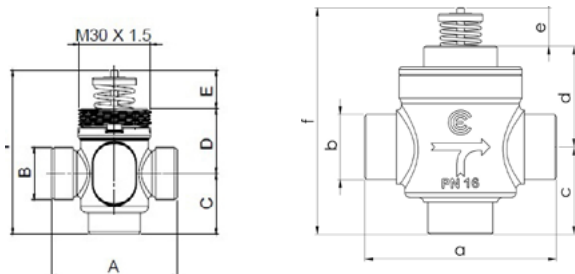

valve	A	B	C	D	E	F	actuator
VMXT09P VMXT10P VMXT11P VMXT12P VMXT13P VMXT13	52	G1/2" M	25	27	15,6	67,6	MVT203S MVT403S MVT503S MVC503R
VMXT21 VMXT21P	56	G3/4" M	34	25,8			
VMXT24P VMXT26P	78	G3/4" M	35,5	41	92,6		
VMXT28P		G1" M					

3-way (4 ports)

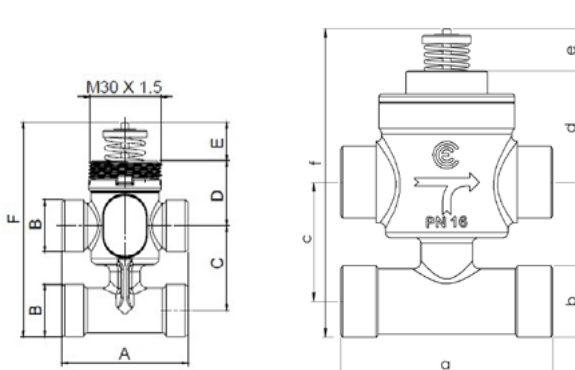

valve	A	B	C	D	E	F	actuator
VTXT09P VTXT10P VTXT11P VTXT12P VTXT13P VTXT13	52	G1/2" M	35	27	15,6	88,4	MVT203S MVT403S MVT503S MVC503R
VTXT09P4 VTXT10P4 VTXT11P4 VTXT12P4 VTXT13P4 VTXT1P4	56	G1/2" M	40				
VTXT21 VTXT21P	56	G3/4" M	50	25,8	98,4		
VTXT21P4	56	G3/4" M	40	25,8	88,4		
VTXT24P VTXT26P	78	G3/4" M	44	41	107,6		

VSXT + MVC503R

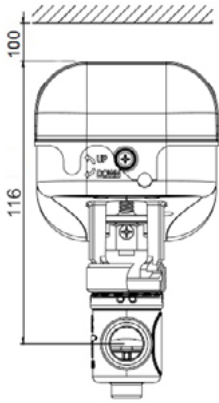

VSXT + MVT.03R

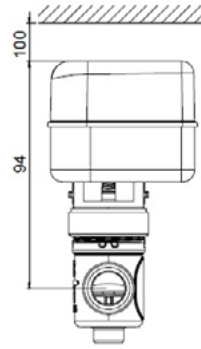

**VSXT24P
VSXT26P
VSXT28P** + MVC503R

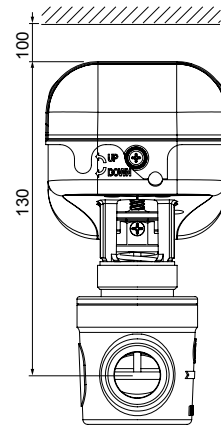

**VSXT24P
VSXT26P
VSXT28P** + MVT.03S

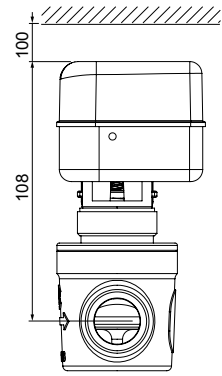

VMXT + MVC503R

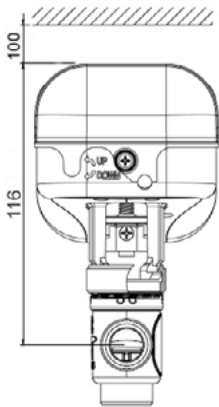

VMXT + MVT.03R

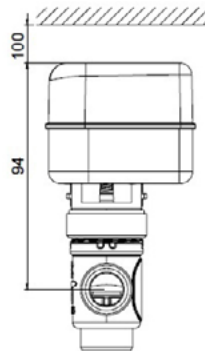

**VMXT24P
VMXT26P
VMXT28P** + MVC503R

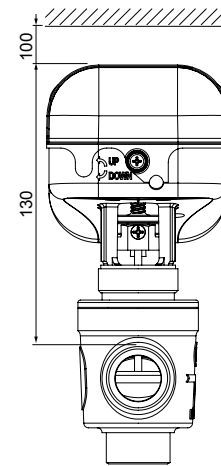

**VMXT24P
VMXT26P
VMXT28P** + MVT.03S

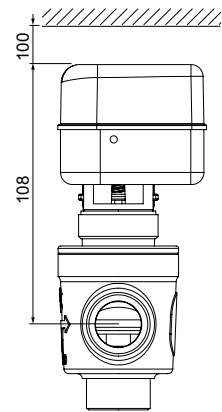

VTXT + MVC503R

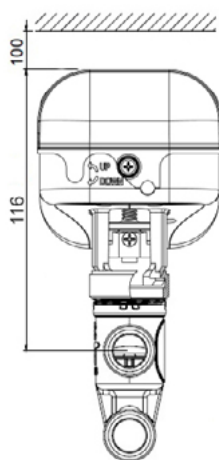

VTXT + MVT.03R

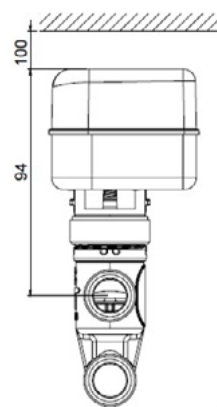

**VTXT24P
VTXT26P** + MVC503R

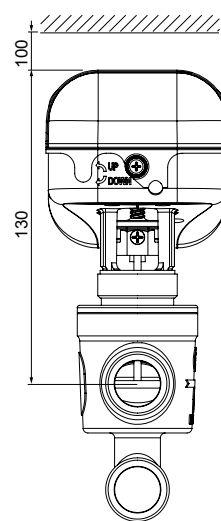

**VTXT24P
VTXT26P** + MVT.03S

