

Smart Balancing Control Valve

MOD.	DN	FLOW [m ³ /h]		PN	Max ΔP [kPa]	POWER SUPPLY
		Qmin	Qmax			
EBV65	65	12	37	16	35-800	24 V AC/DC 230 V AC
EBV80	80	25	59			
EBV100	100	45	77			
EBV125	125	61	118			
EBV150	150	80	177			



APPLICATION AND USE

For years, hydronic systems were controlled by actuated valves that controlled flow to coils and heat transfer equipment. The main goal was to control the heat transfer by controlling the flow, but as pressure changed, flow changed and therefore heat transfer was not efficiently controlled.

Since 1960s control valves designed to maintain design flow regardless of pressure changes in the system has been introduced with the goal to prevent energy wastes due to hot and cold spots in unbalanced hydronic systems. It was a step forward but not enough because the heat transfer depends not only on the flow but also on the ΔT between supply and return; lower is the ΔT , lower is the system efficiency.

In order to meet the energy efficiency need of the Building Automation industry, modern control valves shall be able to directly control the heat transfer and not only the flow: the smart balancing and control valve EBV perfectly fits within this need and it represents the ultimate solutions for heating groups and air handling units control.

The EBV system is able to measure the pressure difference between upstream and downstream of the valve and to maintain the correct flow despite pressure variations thus ensuring that the flow rate changes only when the energy demand changes or the ΔT is outside the specifications.

EBV systems integrates the following functionalities in a unique smart device:

- Pressure independent Control function with ΔT optimizer;
- Energy usage monitoring with Modbus connectivity for a user friendly data analysis;
- Thermal power control function with ΔT optimization;
- Diagnostic/Monitoring available via USB or Modbus-RTU (RS485).

EBV is therefore able to control the coils heat transfer and to guarantee an optimal return temperatures for all operating conditions with a following high level of efficiency in heating and cooling. Thanks to stable temperature control, you can achieve energy savings of up to 25% – without sacrificing comfort.

EBV can be used as an intelligent pressure independent balancing and control valve selecting models without supply and return temperature sensors or it can be used as full thermal power control valve selecting models with supply and return temperature sensors.

Furthermore the Modbus-RTU based Energy monitoring capability as well as the diagnostic and condition monitoring function facilitates work, save times as well as ensure comfort and increase energy efficiency in buildings.

OPERATING

The smart balancing and control valve EBV system is composed by the following elements:

The performances stated in this sheet can be modified without any prior notice.

- Smart high resolution actuator able to collect and elaborate all the data coming from sensors and the BMS (via Modbus) in order to properly position the control valve;
- Flanged Globe Valve with equipercentage control characteristic equipped with pressure sensor plugs;
- a couple of high resolution pressure sensors able to continuously monitor the valve differential pressure;
- a couple of NTC 10 kOhm temperature sensors with stainless steel cases able to continuously monitor the supply and return fluid temperature.

EBV can be controlled by 2 types of signal:

- Modbus command;
- modulating (or proportional) with selectable range of action 0-10 V DC (default), 2-10 V DC, 0-5/2-6 V DC, 5-10/6-10 V DC and 4-20 mA.

The command mode can be set via Modbus or via USB or via the dipswitches on the board.

The setting of the fields in sequence for the modulating signal (0-5/2-6 V DC and 5-10/6-10 V DC) can only be set via the configurator.

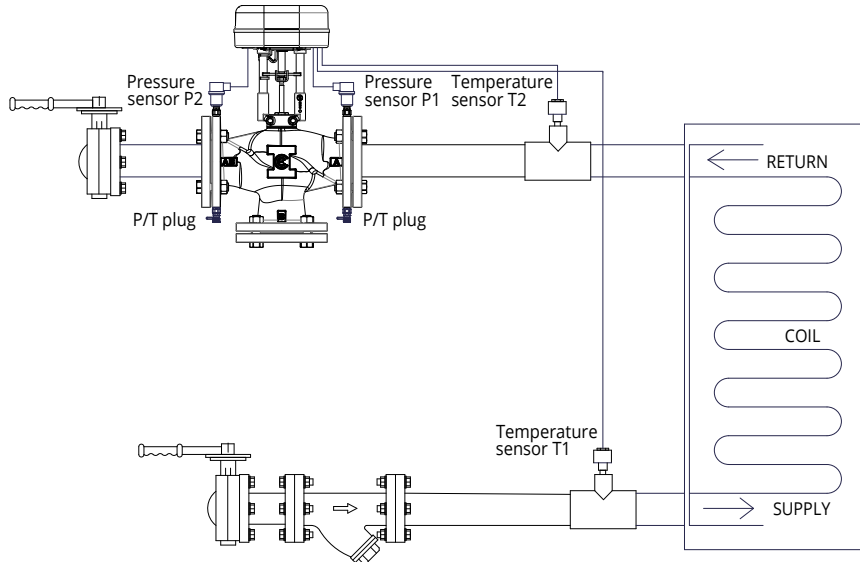

EBV system receives the flow rate set point from the BMS (0-10 V signal or 0-100% Modbus signal) and defines the valve position in order to keep this flow rate constant as the pressure changes.

By using the temperature sensors (available on specific models EBVxxx-xxx-xx1) it is also possible to control the thermal power exchanged by the coil. In this case, the signal received by the BMS represents the set-point of the thermal power supplied by the exchanger. The EBV then regulates the flow rate necessary to ensure the set heat output according to the current supply and return temperatures.

It is also possible to enable the ΔT maximization function in order to reduce the flow rate value in the presence of a ΔT that is too low and therefore increasing the efficiency of the system.

Furthermore, the operating parameters, faults and the energy consumption history are made available via Modbus-RTU protocol and via USB connection (not simultaneously).

The firmware can be upgraded via USB port. For further details refer to the DMP116en manual.

TECHNICAL DATA

ENVIRONMENTAL DATA		
Temperature rating, media		-10°C to 120°C
Working temp., environment		-10°C to 50 °C
Protection	Actuator	IP54
	Temp. sensors	IP65
	Pressure sensors	IP65

ELECTRICAL DATA	
Supply voltage	24 V AC/DC, 230 V AC
Control signal	0-10 V DC, 2-10 V DC, 0-5/2-6 V DC, 5-10/6-10 V DC and 4-20 mA or 0-100% Modbus control signal
Output signal	2-10 V DC (0-100%); max load 2 mA or 0-100% Modbus signal

HYDRAULIC DATA		
Valve connections	Flanged PN16	
Fluids	water, glycol-water mixture (50% max)	
Min/Max flow rate range *	DN65	12000 / 37000 l/h
	DN80	25000 / 59000 l/h
	DN100	45000 / 77000 l/h
	DN125	61000 / 118000 l/h
	DN150	80000 / 177000 l/h
Max. close off pressure	800 kPa	
Max. operational ΔP	800 kPa	
Min. operational ΔP	35 kPa	
Allowable operating pressure	1600 kPa max	
Max consumption	21 VA / 11 W	
Transformer sizing	50 VA	
Standard	Emission/Immunity EMC 2014/30/UE according to EN 61326-1:2013 standard LVD 2014/35/UE according to EN61010-1 standard	

* Qmin and Qmax refer to the Modbus 100% control signal or 10 V (0-10 V control signal).

PRESSURE SENSORS	
Pressure Range	0 to 16 bar
Media Temp. Range	-15°C to 125°C
Output signal	0-10 V DC
Power Supply	16 V DC (supplied from the actuator)
Valve connection	1/8 "

TEMPERATURE SENSORS	
Type	NTC 10 kOhm ($\beta @ 25^\circ = 3435$)
Temperature Range	-50°C to 110°C

Note: temperature sensors available in EBVxxx-xxx-xx1 models only

BMS Connectivity: Modbus-RTU (slave)

FUNCTIONS AND SETTINGS

EBV smart balancing control valve can offer the followings features

Position Control

The actuator receive the modulating signal coming from a control loop implemented by the BMS and the valve is positioned from 0% to 100% accordingly to the voltage (0...10 V DC) or current signal (4...20 mA).

Pressure Independent Control Function

The control signal coming from the BMS (i.e. 0...10 V DC) has to be considered as the flow rate set point the BMS wants to deliver to the specific coil (Input 0 V Flow 0; Input 10 V: Flow: Qmax). The positioning algorithm set the valve position considering the valve characteristics and the current differential pressure across the valve. This function allows to control the flow delivered to the coil regardless the pressure fluctuations in the system.

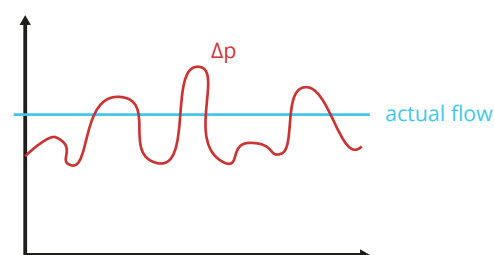

The flow setpoint is determined by the setting of the desired maximum flow rate (Q_{set}) and by the control signal from the BMS through an equal percentage equation.

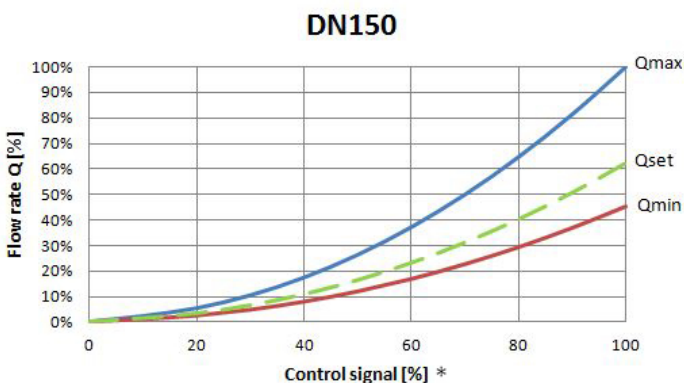
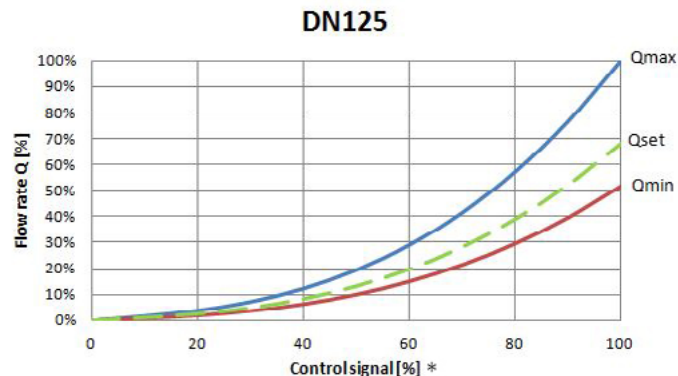
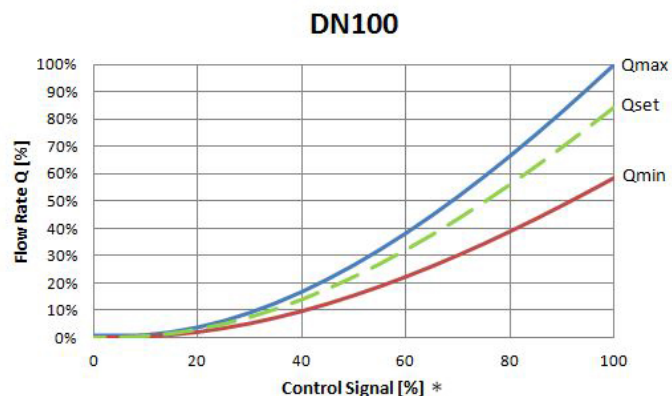
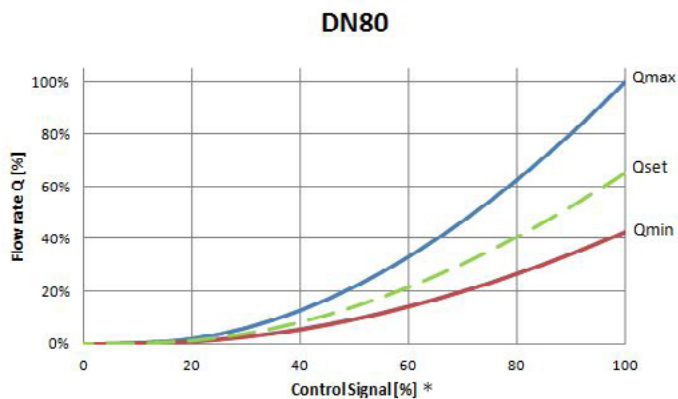
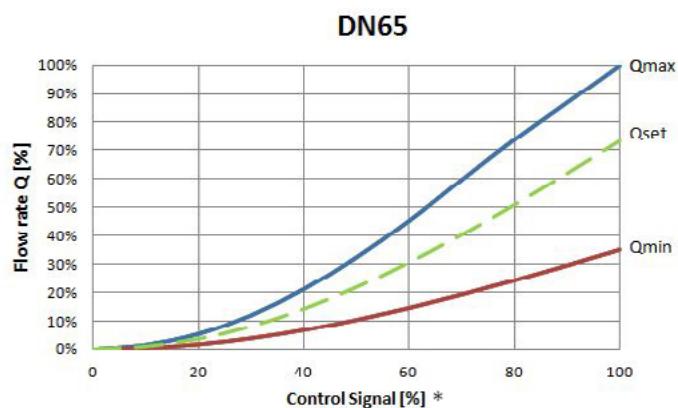

* 100% control corresponds to 10 V with 0-10 V control signal.

It is possible to set the desired maximum flow rate whose value is included between the values of Q_{max} and Q_{min} defined for valve. To do this, the configuration tool is available which can be used both with the Modbus connection and via USB. For further details refer to the DMP116en manual. By default the value of the maximum desired flow rate is set to the maximum flow rate value. The maximum desired flow rate value corresponds to the maximum command signal (generally 10 V or 100%).

For pressure differences below 0.01 bar, the flow rate calculated is 0 l/h and the valve position does not depend on the positioning algorithm, but directly on the control signal set by the BMS.

Heat Transfer Control Function (only for EBVxxx-xxx-xx1 models with temperature sensors)

The control signal coming from the BMS (i.e. 0..10 V DC) has to be considered as the heat transfer setpoint the BMS wants to deliver to the specific coil.

The positioning algorithm calculates the position of the valve considering its characteristic curve, the differential pressure across it and the current supply and return temperature. This function allows you to calculate the thermal power transferred from the coil and to control it independently of pressure fluctuations in the systems and other external conditions that could affect the heat transfer process, lowering the overall efficiency.

It is possible to set the maximum desired power (P_{max}) whose value is between the nominal power values (P_{nom}) defined for the valve at the various ΔT and shown in the following table. To do this, the configuration tool is available that can be used both with the Modbus connection and via USB. For further details refer to the DMP116en manual.

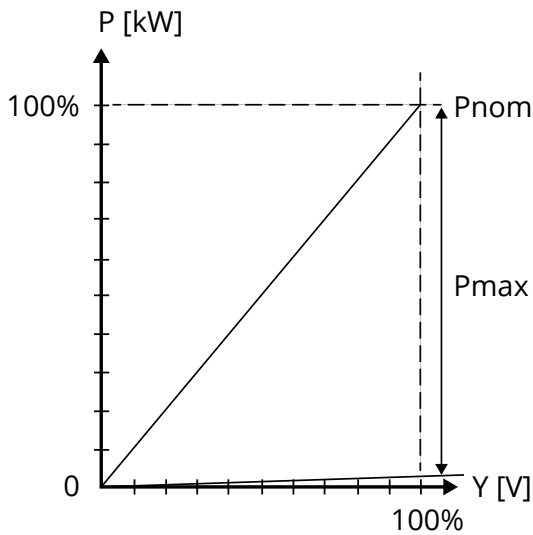

Maximum power values controllable by the valve are determined according to the ΔT 6K, 10K, 15K and 20K.

DN	NOMINAL POWER [kW]			
	ΔT 6K	ΔT 10K	ΔT 15K	ΔT 20K
65	253	422	633	843
80	403	672	1009	1345
100	527	878	1316	1755
125	807	1345	2017	2690
150	1210	2017	3026	4034

ΔT maximization function (only for EBVxxx-xxx-xx1 models with temperature sensors)

EBV limits the flow rate automatically to prevent the ΔT from falling below the setting value.

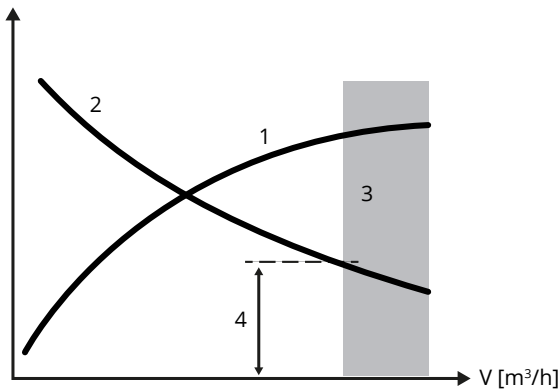

- 1 - Power output of the heating or cooling registers
- 2 - Diff. temperature between supply and return
- 3 - Loss zone (heating or cooling saturation)
- 4 - Adjustable minimum differential temperature

Energy Monitoring Function (only for EBVxxx-xxx-xx1 models with temperature sensors)

When equipped with temperature sensors installed on the supply and return line of a coil, EBV is able to calculate the instantaneous thermal power and the energy (heating\cooling) delivered by controlled coil. The current data, e.g. temperatures, flow rates, heating\cooling energy consumptions etc. can be recorded and accessed at any time by means Modbus connection.

Manual Override

There is a manual operation handle on the actuator. When it is low the manual override is engaged and the valve can be manually positioned. The manual override lever stays in position until it is raised again, then board and motor will be powered again. When the manual override is engaged the GREEN and the RED LED are ON.

Manual operation handle can also be used to modify any DIP switch setting or as re-set function after any alarm occurrence.

Position Feedback

The current position of EBV system is made available via Modbus (0-100%) as well as via a 2-10 V DC analog signal.

Calibration function

EBV is equipped with an automatic calibration function.

The plug & play function enables the calibration at the first start-up of the actuator and therefore no further calibration operations are required unless maintenance is required on the valve or particular alarm conditions occur. If it is necessary to repeat the calibration, it can be activated by pressing the S2 button on the electronic board or remotely via Modbus.

Auxiliary limit switches (DMVE accessory)

The limit switches switch when the valve is fully open or closed. These are dry contacts (24 V AC/DC, 4 A max). Auxiliary switches can be used to indicate the end position of the valve and for relay control of other system devices.

When the actuators are controlled individually or in sequence, it is possible to use the limit switches to indicate the total closing or opening of the valve. The table below indicates the position of the switch based on the 0..10 V DC (Y) command signal.

Control signal (Y)	Relay KC1	Relay KC2
0-0,5 V DC	KC1 to K2	KC2 to K3
0,5-9,5 V DC	KC1 to K1	KC2 to K3
9,5-10 V DC	KC1 to K1	KC2 to K4

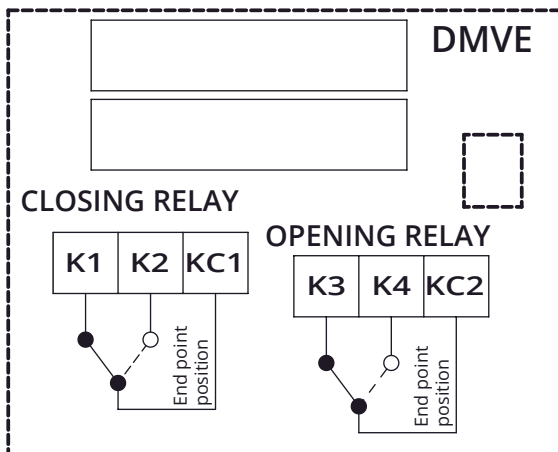

Diagnostic

EBV is equipped with a self-diagnostic algorithm capable of detecting the following conditions/anomalies:

- Status of the actuator (Normal Operation, Calibration, Initial positioning, Fault, Manual).
- Calibration errors on a stroke not included in the 5-60 mm range.
- Unexpected stall errors (e.g. blocked valve or over-travel due to actuator not coupled correctly); the number of events detected is saved permanently.
- Power supply voltage outside the allowed range; the number of events detected is saved permanently.
- Total number of opening and closing cycles.
- Temperature sensors outside the permitted temperature range (if any).

For the correct assembly of EBV see the Installation Instruction (EBV_DIM324).

MAINTENANCE

The actuator is maintenance-free.

ACCESSORIES

DMVE	Auxiliary limit switches (electrical characteristics 24 V AC/DC, 4 A max)
248	Stem heater (recommended when the fluid tem
GMVE	Thermal insulation shell for MVE *
CONV-USB-RS485	USB-RS485 converter cable
SNTC-SL-3	NTC 10K temperature sensor 3 m length (10 m length available on request)

* It is not possible to install the thermal insulation shell and the stem heater at the same time.

ELECTRICAL CONNECTIONS

Remove the cover screw with a screwdriver and then remove the cover as shown in the picture beside.

The actuator is equipped with 3 removable terminal block:

- a removable 8-poles terminal block (T1) with power supply, analog and digital command signal and



feedback signal; each terminal pole is clearly marked and the same label is shown on the electronic board. Before turning on the actuator, make sure that the terminal block is correctly connected to the board and that the label on the terminals and board match;

- a removable 6-poles terminal block (T2) dedicated to the RS485 bus connection (Modbus);
- a removable 6-poles terminal block (T3) dedicated to the connections of the temperature sensors (only 4 poles are used).

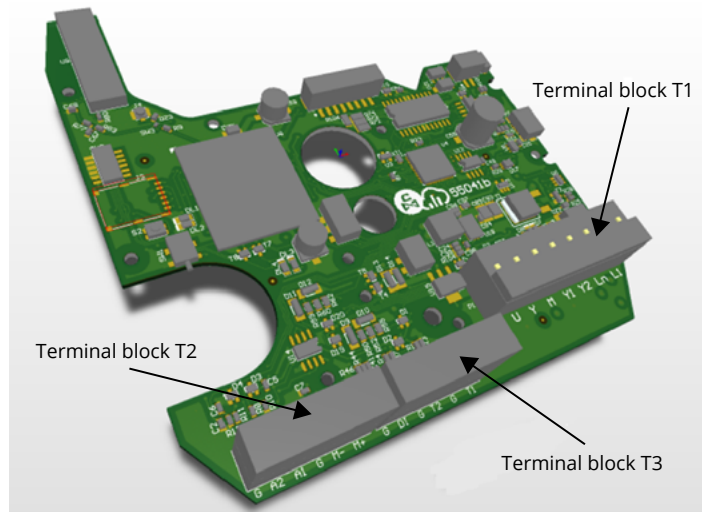

The actuator is supplied with 2 cable glands with die-cut membranes for safe wiring.

- Cable gland 1 for 3 cables: 2-wires cable for power supply; 5-wires cable for control and feedback signals and 3-wires cable for Modbus;
- Cable gland 2 for 4 cables: 2-wires cable for T1 temperature sensor, 2-wires cable for T2 temperature sensor and 3-wires cable for pressure sensor P1 and P2 respectively.

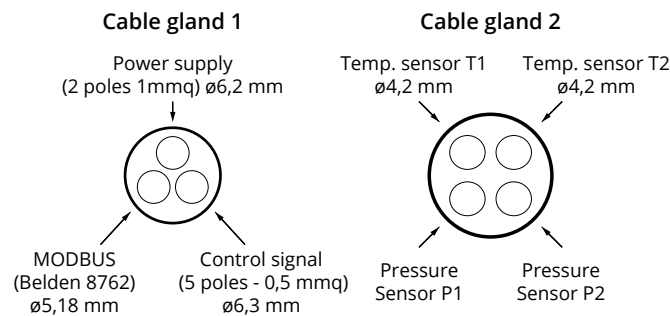

Terminal block T1

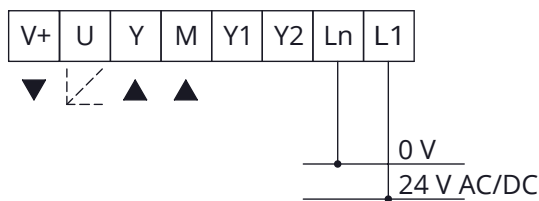

Label	Description	Function	Cable type	Max wire length
L1	24 V AC/DC	Power supply	AWG 16 (min 1 mm ² - max 1,5 mm ²)	75 m
Ln	0 V			
Y	0-10 V DC	Modulating control input	AWG 20 (min 0,5 mm ² - max 1,5 mm ²)	200 m
M	0 V (common)			
Y1		Not used		
Y2				
V+	16 V DC	Power supply for pressure sensors	AWG 20 (min 0,5 mm ² - max 1,5 mm ²)	200 m
M	0 V (common)			
U	2-10 V DC	Feedback output signal	AWG 20 (min 0,5 mm ² - max 1,5 mm ²)	200 m
M	0 V (common)			

Terminal block T2

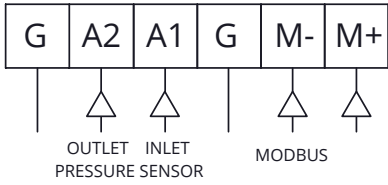

Label	Description	Function	Cable type	Max wire length
M+	Tx	Modbus connection	Belden 8762	See chapter Modbus - RS485
M-	Rx			
G	Shield			

Terminal block T3

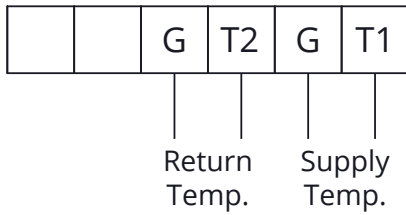

Label	Description	Function	Max wire length
T1	Supply temp. sensor	Temperature control loop and ΔT limit function	10 m
G	Common		
T2	Return temp. sensor		
G	Common		

Wiring Diagrams

Modbus control

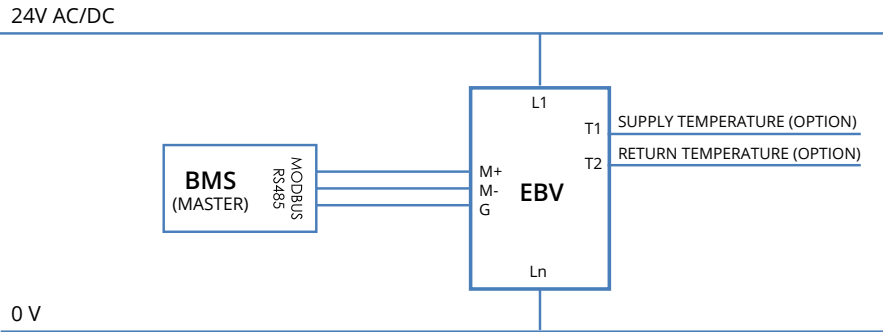

Modulating Control & Modbus Supervisory

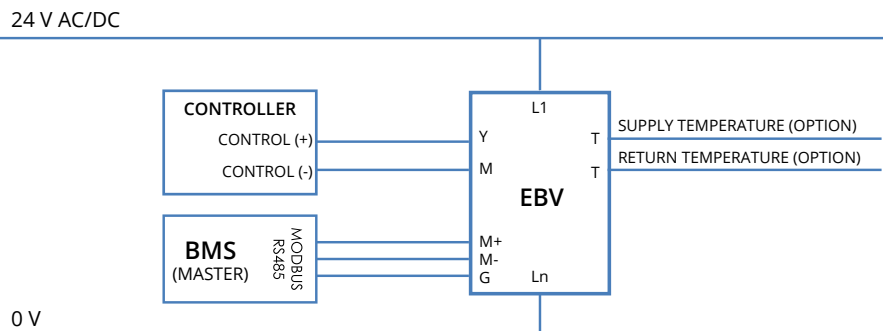

Modbus - RS485 connection

RS485 network is made with a 3-conductor cable, which will be recognized below with “+” (M+), “-” (M-) and “GND” (pin G). For wiring, we recommend the Belden® cable, model 8762. In particularly “noisy” environments, we recommend the Belden® cable, model 3106A connecting the twisted pair respectively to the “+” and “-” signals, the reference conductor to GND and the screen on the ground.

Alternatively, a cable with the following electrical and mechanical characteristics can be used:

AWG 20/22;

characteristic impedance of 120 Ω;

with copper conductors, of the “braid” type, twisted;

with braided shielding and protective insulation.

The shield must be connected to the GND signal (pin 25) of the actuator.

The network must only be wired according to the following principle, defined as a “daisy chain” (the device consists of a single RS485 port). Star connections are not allowed.

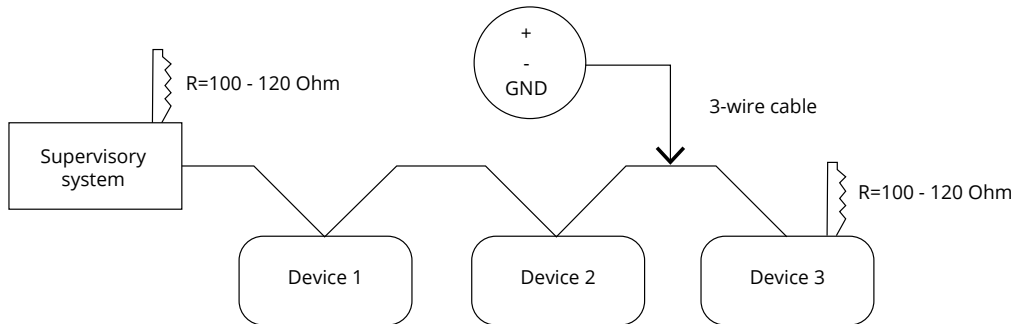

Connection warnings

For correct wiring of the network it is recommended to respect the following warnings:

1. Do not use different types of cable to create the same network, but always and only use the same type of cable;
2. The network cable is crossed by SELV safety voltage signals and must not be wired in channels intended for cables with dangerous voltages (for example 230Vac) or carriers of high currents, especially if in alternating current. Also avoid parallel paths to these power cables;
3. Wire the cable as straight as possible, avoiding folds with tight bending radius, let alone wrapping it in unnecessary charges;
4. Do not twist the cable around power conductors and, if you have to cross them, provide a 90 ° cross between the cable and these conductors;
5. Keep away from electromagnetic field sources, in particular from large motors, switchboards, neon ballasts, antennas of all types;
6. Avoid that the pull tension of the cables exceeds 110N (11.3 kg) to prevent ironing;
7. Evaluate the route in advance so as to shorten it as much as possible and take note of the addresses of the instruments connected with particular reference to their location in orderly sequence. This can be very useful in maintenance; We recommend that you take note of the Modbus address and report it on the product label in the space provided for it.
8. Do not invert the polarity “+” and “-” at the connection terminals;
9. Avoid short pieces of cable in the connection terminals to the instruments, in order to allow a possible maintenance without tearing or pulling of the cable itself;
10. Identify the start and end terminations and avoid “open” segments; Termination resistors and network polarization The slew-rate control, common to all our converters, and the baud rate limited to 9600 baud (bit/sec) make termination resistors unnecessary. The RS485 network requires polarization typically borne by the Master device; the regulator does not have polarization resistors. The transceiver used by the actuator allows to drive up to 256 knots.

The RS485 standards provide for a maximum length of 1200 m and/or 32 devices on the network. However, it should be noted that the more the “standard” limits are exceeded (maximum limit of 32 devices or cable lengths greater than 1200 m), the higher the probability that communication problems will arise. The phenomenon is not systematic and may not even occur.

Vice versa, if it occurs, and none of the points indicated in this paragraph has allowed to solve the problem, the connection of a repeater (code CONV-RS485-RIP) is suggested, as shown in the figure below:

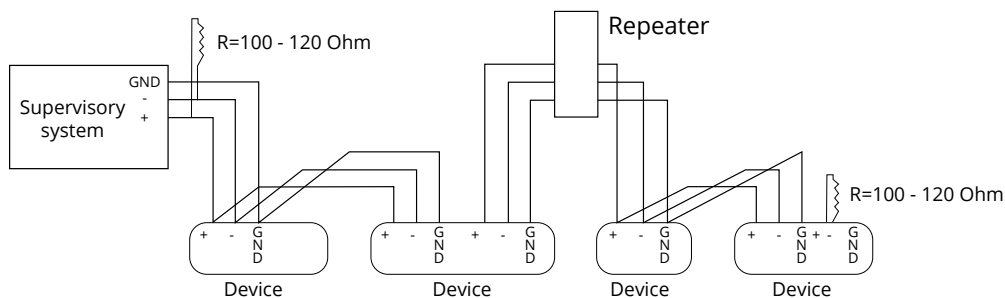

NOTE - Use a repeater if the cable length exceeds 1200 m or if there are more than 32 devices.

DIPSWITCH SETTING

DEFAULT SETTINGS

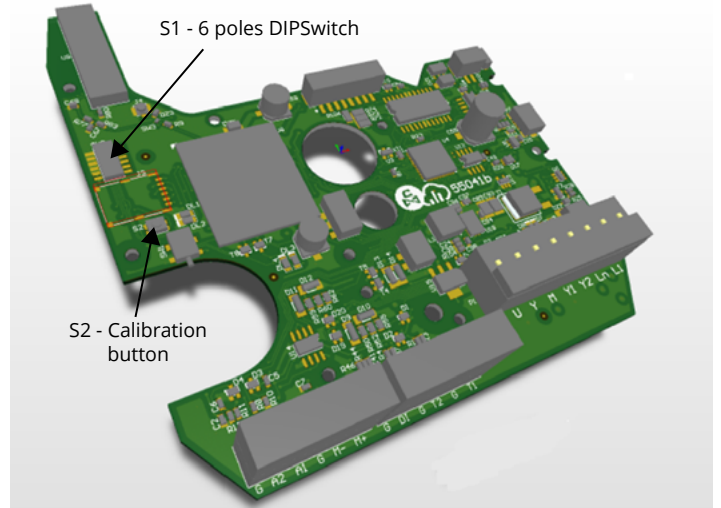
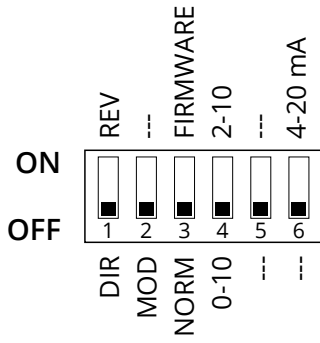

DIP switch	OFF	ON
1	Direct action	Reverse action
2	Modulating Control (MOD) (Input between Y [+] and M [-])	Not used
3	Normal operating	Firmware update
4	Modulating Control 0-10 V DC (DIP n. 2 OFF only)	Modulating Control 2-10 V DC (DIP n. 2 OFF only)
5	Not used	Not used
6	Voltage Input Signal (input between Y [+] and M [-])	Current Input Signal 4-20mA (input between Y [+] and M [-])

STANDARD LEDs BEHAVIOUR

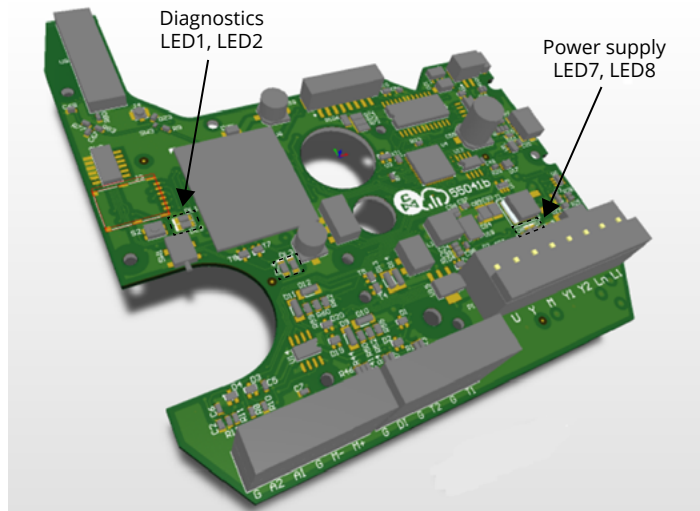

N°	LED 1 and 2	Actuator status
1	FIXED GREEN	Actuator at end point of the calibrated stroke
2	GREEN SLOW BLINKING	Actuator has arrived or is moving towards an intermediate point of the calibrated stroke
3	RED and GREEN BLINKING ALTERNATIVELY	Actuator is calibrating the stroke or performing the initial positioning
4	RED and GREEN FIXED	Manual control activated, the actuator ignores the control signal. WARNING! The board is powered

N°	LED 7 (RED) and 8 (RED)	Actuator status
1	LED 7 RED ON; LED 8 RED ON	Stable power supply of the actuator
2	LED 7 RED ON; LED 8 OFF	Unstable actuator power supply; possible hardware problem

DIMENSIONS [mm]

Mod.	DN	L	H	h	D	b	a	f	Holes	Weight [kg]
EBV	65	290	320	175	185	20	145	18	4	18
	80	310	330	186	200	22	160	18	8	28
	100	350	341	206	220	24	180	18	8	32
	125	400	364	255	250	26	210	22	8	45
	150	480	382	275	285	26	240	25	8	60

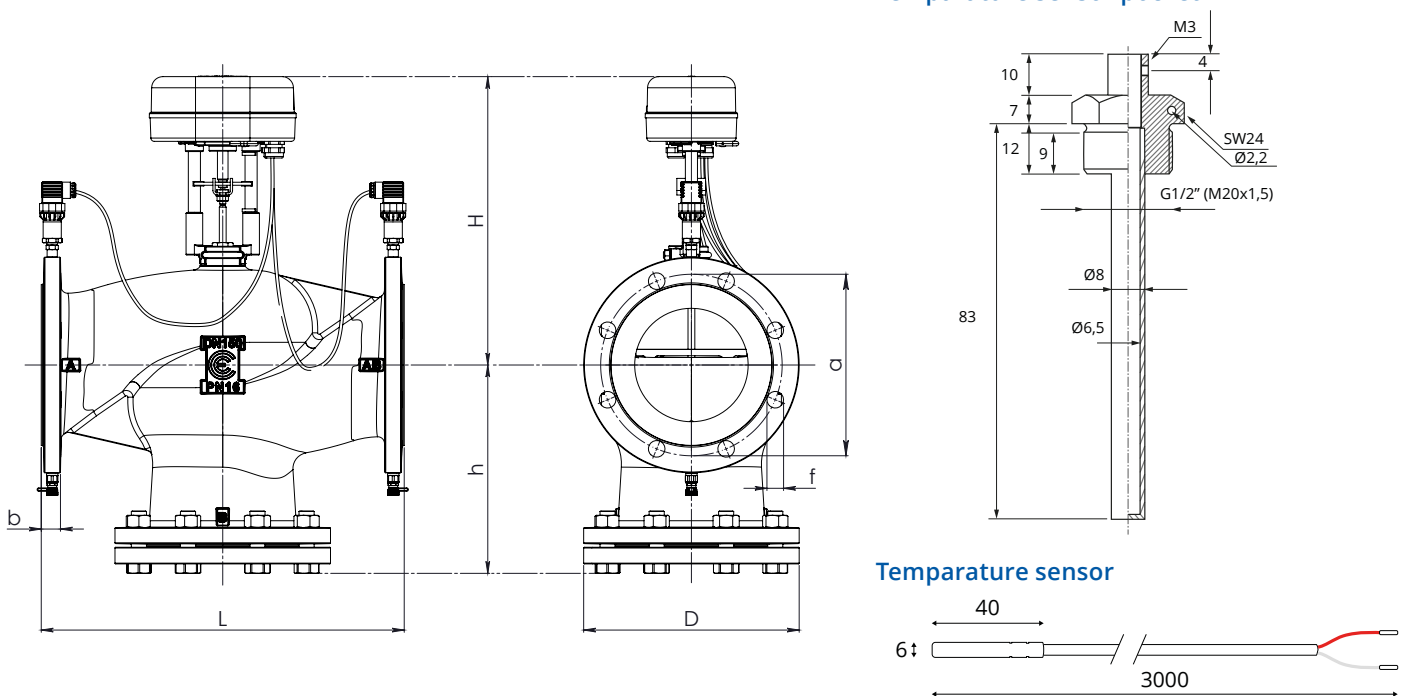

ORDERING PART NUMBER

65 = DN65, max flow 37 m³/h
 80 = DN80, max flow 59 m³/h
 100 = DN100, max flow 77 m³/h
 125 = DN125, max flow 118 m³/h
 150 = DN150, max flow 177 m³/h

024 = Power supply 24 V AC/DC
 230 = Power supply 230 V AC

EBVXX-XXX-XXX

0 = No emergency return
 1 = With emergency return

0 = Modbus connection

0 = No temperature sensors
 1 = With temperature sensors

Example: **EBV65-024-001** → Max flow 37 m³/h, DN65, 24 V AC/DC, No emergency return, with Modbus connection, with Energy function enabled and 2 temperature sensors included

N°	Error type	Actuator status	Actuator behavior	LEDs notification	Possible anomaly	Restore procedure
1	Stroke less than 5 mm	Calibration / first installation	The actuator returns to its initial position and does not respond to the command. The actuator keeps the previous stroke or the default stroke	RED ON	Valve with stroke less than 5 mm	Remove power and re-power again
	Stroke greater than 60 mm	Calibration / first installation	The actuator leaves the maximum range of 60mm and moves to the new extreme. Once the new stroke limit is reached, it returns to the initial position signaling an anomaly. The actuator does not learn the new stroke.	RED fast blinking + GREEN ON	Valve with stroke greater than 60 mm or incorrect coupling	Remove power and re-power again
2	Unexpected collision within the stroke	Normal operation	The actuator checks the stall condition 5 times. At the end of the attempts it signals an anomaly. The actuator does NOT learn the new stroke, but after 60s repeats the attempts to check the blocking conditions	RED fast blinking	Valve blocked	Reverse the control signal
3	Stroke greater than expected	Normal operation	The actuator moves to the new crash position with low speed signaling an anomaly. The actuator does NOT learn the new stroke	RED fast blinking	Damaged valve or incorrect coupling	Reverse the control signal
4	Low supply voltage	Normal operation	The actuator continues to operate but performance is not guaranteed. If the low voltage events persist (events greater than 10), the actuator stops working.	RED blinking alternately fast (5sec) and slow (5sec) + GREEN ON	1. Wrong sizing of transformer 2. Unstable power supply	Check and restore power
5	High supply voltage	Normal operation	The actuator continues to operate but performance is not guaranteed. If the high voltage events persist (events greater than 10), the actuator stops working.	RED slow blinking	1. Wrong sizing of transformer 2. Unstable power supply	Check and restore power
6	Temperature sensors error	Normal operation	Temperature or ΔT regulation loops not working	RED blinking alternately fast (5sec) and slow (5sec) + GREEN ON	1. Incorrect temperature probe connection 2. Temperature probes damaged 3. Temperature detected outside the range of use	Check the connection and the condition of the temperature sensor
7	Pressure sensors error	Normal operation	Pressure or ΔP regulation Loops not working		Pressure detected outside the range of use or probes damaged	